



KOTŁY KONDENSACYJNE

Nazwa wyrobu	Nr katalogowy	Moc [kW]	Rodzaj gazu	Cena netto [PLN]	Cena brutto [PLN]
--------------	---------------	----------	-------------	------------------	-------------------

KOTŁY JEDNOFUNKCYJNE



Thermagen Solo 18	TH04-0011	5,4-17,8	Ziemny 2E-G20 (dawny GZ-50)	5050,00	6211,50
Thermagen Solo 24	TH04-0012	6,9-22,8		5400,00	6642,00
Thermagen Solo 30	TH04-0013	7,1-26,3		5700,00	7011,00
Thermagen Solo 46	TH04-0014	8,6-40,9		6300,00	7749,00

Nazwa wyrobu	Nr katalogowy	Moc [kW]	Rodzaj gazu	Cena netto [PLN]	Cena brutto [PLN]
--------------	---------------	----------	-------------	------------------	-------------------

KOTŁY DWUFUNKCYJNE



Thermagen Duo 24/18	TH04-0021	6,1-21* 5,4-17,8	Ziemny 2E-G20 (dawny GZ-50)	5600,00	6888,00
Thermagen Duo 28/24	TH04-0022	7,8-27* 6,9-22,8		5950,00	7318,50
Thermagen Duo 36/30	TH04-0023	8-31,5* 7,1-26,3		6300,00	7749,00
Thermagen Duo 36/46	TH04-0024	8-31,5* 8,6-40,9		6850,00	8425,50

(*)moc kotła dla funkcji ciepłej wody

Istnieje możliwość odpłatnego przebrojenia kotła przez Autoryzowany Serwis na gaz propan G31.

Na wyposażeniu kotła:

- Adapter koncentryczny $\varnothing 80/125$
nr kat. TH09-0002
- Zestaw przyłączeniowy Solo lub Duo
nr kat. TH09-0041/TH09-0042
- Listwa montażowa
nr kat. TH09-0004
- Syfon kondensatu
nr kat. 844187



PAKIETY



KOCIOŁ



WYMIENNIK C.W.U.



ZAWÓR TRÓJDROŻNY



CZUJNIK TEMP. WYMIENNIKA C.W.U.

BEZPRZEWODOWY REGULATOR OT

ZESTAW DO SZACHTU 80/125

Nazwa wyrobu/typ	Dodatkowe elementy w zestawie	Numer katalogowy	Cena netto [PLN]	Cena brutto [PLN]
Pakiet Solo 18 DeLux		TH09-0105	9700,00	11931,50
Pakiet Solo 24 DeLux	<p>Thermagen Splash</p>	TH09-0106	10100,00	12423,00
Pakiet Solo 18 Lux		TH09-0107	7500,00	9225,00
Pakiet Solo 24 Lux	<p>Thermagen Eco Splash</p>	TH09-0108	7850,00	9655,50



KOCIOŁ



WYMIENNIK C.W.U.

ZAWÓR TRÓJDROŻNY

CZUJNIK TEMP.
WYMIENNIKA C.W.U.

Nazwa wyrobu/typ	Dodatkowe elementy w zestawie	Numer katalogowy	Cena netto [PLN]	Cena brutto [PLN]
Pakiet Solo 18 + Splash 120		TH09-0101	8950,00	11008,00
Pakiet Solo 24 + Splash 120		TH09-0102	9250,00	11377,00
Pakiet Solo 18 + EcoSplash 120		TH09-0103	6850,00	8425,50
Pakiet Solo 24 + EcoSplash 120		TH09-0104	7200,00	8856,00

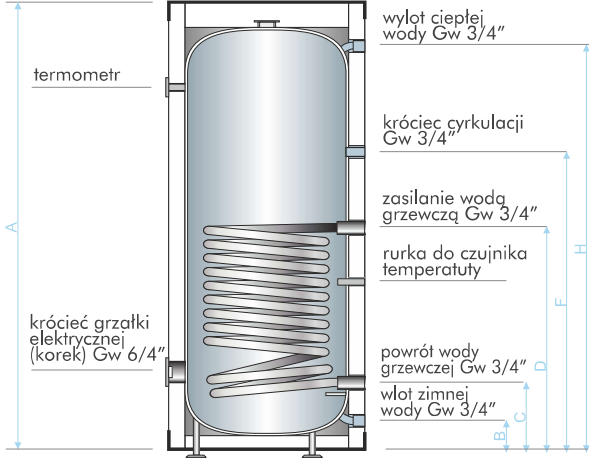

WYMIENNIKI C.W.U. I AKCESORIA

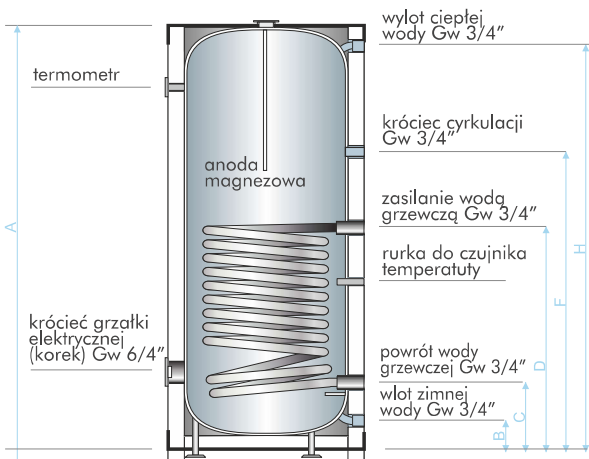
Nazwa wyrobu	Numer katalogowy	Cena netto [PLN]	Cena brutto [PLN]																																			
 <p>Wymiennik cwu Thermagen Splash 120, wykonany ze stali kwasoodpornej.</p>  <p>termometr</p> <p>wylot ciepłej wody Gw 3/4"</p> <p>króciec cyrkulacji Gw 3/4"</p> <p>zasilanie wodą grzewczą Gw 3/4"</p> <p> rurka do czujnika temperatury</p> <p>powrót wody grzewczej Gw 3/4"</p> <p>włot zimnej wody Gw 3/4"</p> <p>króciec grzałki elektrycznej (korek) Gw 6/4"</p> <p>C</p>	TH09-0020	3000,00	3690,41																																			
<table border="1"> <thead> <tr> <th>średnica</th> <th>A</th> <th>B</th> <th>C</th> <th>D</th> <th>F</th> <th>H</th> </tr> <tr> <th colspan="7">(mm)</th> </tr> </thead> <tbody> <tr> <td>500</td> <td>1365</td> <td>111</td> <td>214</td> <td>822</td> <td>912</td> <td>1235</td> </tr> <tr> <th>pojemność (l)</th> <th>powierzchnia wężownicy (m²)</th> <th>moc wężownicy* (kW)</th> <th>straty postojowe** (W)</th> <th colspan="3"></th> </tr> <tr> <td>125</td> <td>1,0</td> <td>30</td> <td>70</td> <td colspan="3"></td> </tr> </tbody> </table> <p>* przy parametrach 80/10/45°C (temp. wody grzewczej/temp. wody zasilającej/ temp. c.w.u.), przepływ wody grzewczej przez wężownicę 2,5 m³/h ** Zgodnie z rozporządzeniem komisji (EU) 812/2013, 814/2013</p> <p>Ciśnienie znamionowe: zbiornik 0,6 Mpa, wężownica 1,0 MPa Klasa efektywności energetycznej: C</p>				średnica	A	B	C	D	F	H	(mm)							500	1365	111	214	822	912	1235	pojemność (l)	powierzchnia wężownicy (m ²)	moc wężownicy* (kW)	straty postojowe** (W)				125	1,0	30	70			
średnica	A	B	C	D	F	H																																
(mm)																																						
500	1365	111	214	822	912	1235																																
pojemność (l)	powierzchnia wężownicy (m ²)	moc wężownicy* (kW)	straty postojowe** (W)																																			
125	1,0	30	70																																			





Nazwa wyrobu	Numer katalogowy	Cena netto [PLN]	Cena brutto [PLN]																																			
 <p>Thermagen EcoSplash 120 wykonany ze stali emaliowanej.</p>  <p>termometr</p> <p>wylot ciepłej wody Gw 3/4"</p> <p>króciec cyrkulacji Gw 3/4"</p> <p>zasilanie wodą grzewczą Gw 3/4"</p> <p> rurka do czujnika temperatury</p> <p>powrót wody grzewczej Gw 3/4"</p> <p>włot zimnej wody Gw 3/4"</p> <p>króciec grzałki elektrycznej (korek) Gw 6/4"</p> <p>anoda magnezowa</p> <p>C</p>	TH09-0021	1100,00	1353,00																																			
<table border="1"> <thead> <tr> <th>średnica</th> <th>A</th> <th>B</th> <th>C</th> <th>D</th> <th>F</th> <th>H</th> </tr> <tr> <th colspan="7">(mm)</th> </tr> </thead> <tbody> <tr> <td>500</td> <td>1365</td> <td>111</td> <td>214</td> <td>822</td> <td>912</td> <td>1235</td> </tr> <tr> <th>pojemność (l)</th> <th>powierzchnia wężownicy (m²)</th> <th>moc wężownicy* (kW)</th> <th>straty postojowe** (W)</th> <th colspan="3"></th> </tr> <tr> <td>124</td> <td>1,0</td> <td>30</td> <td>72</td> <td colspan="3"></td> </tr> </tbody> </table> <p>* przy parametrach 80/10/45°C (temp. wody grzewczej/temp. wody zasilającej/ temp. c.w.u.), przepływ wody grzewczej przez wężownicę 2,5 m³/h ** Zgodnie z rozporządzeniem komisji (EU) 812/2013, 814/2013</p> <p>Ciśnienie znamionowe: zbiornik 0,6 Mpa, wężownica 1,0 MPa Klasa efektywności energetycznej: C Model anody magnezowej : TH09-0043</p>				średnica	A	B	C	D	F	H	(mm)							500	1365	111	214	822	912	1235	pojemność (l)	powierzchnia wężownicy (m ²)	moc wężownicy* (kW)	straty postojowe** (W)				124	1,0	30	72			
średnica	A	B	C	D	F	H																																
(mm)																																						
500	1365	111	214	822	912	1235																																
pojemność (l)	powierzchnia wężownicy (m ²)	moc wężownicy* (kW)	straty postojowe** (W)																																			
124	1,0	30	72																																			



WYMIENNIKI C.W.U. I AKCESORIA











Nazwa wyrobu		Numer katalogowy	Cena netto [PLN]	Cena brutto [PLN]
	Anoda magnezowa	TH09-0043	44,00	54,12
	Zawór trójdrożny 3/4"	TH09-0016	384,00	472,32
	Czujnik temperatury wymiennika c.w.u.	TH09-0012	53,00	65,19

SYSTEMY REGULACJI

Nazwa wyrobu		Numer katalogowy	Cena netto [PLN]	Cena brutto [PLN]
	Bezprzewodowy regulator OT	TH09-0017	230,00	282,90
	Bramka internetowa	TH09-0018	386,00	474,78
	Bezprzewodowy regulator OT kolorowy	TH09-0019	950,00	1168,50
	Bezprzewodowa głowica termostatyczna	TH09-0040	350,00	430,50







AKCESORIA DO KOTŁÓW

	Nazwa wyrobu	Numer katalogowy	Cena netto [PLN]	Cena brutto [PLN]
	Adapter koncentryczny ø60/100	TH09-0001	214,00	263,22
	Adapter koncentryczny ø80/125	TH09-0002	214,00	263,22
	Adapter spalinowy ø80	TH09-0003	150,00	184,50
	Listwa montażowa	TH09-0004	21,00	25,83
	Zestaw przyłączeniowy Solo: 2x złączka zaciskowa 22x3/4", 1x złączka zaciskowa 15x1/2", zawór bezp. 3bar, zawór spustowy, 2x trójnik	TH09-0041	107,00	131,61
	Zestaw przyłączeniowy Duo: 2x złączka zaciskowa 22x3/4", 3x złączka zaciskowa 15x1/2", zawór bezp. 3bar, zawór spustowy, 2x trójnik	TH09-0042	125,00	153,75
	Czujnik temperatury zewnętrznej	TH09-0005	96,00	118,08
	Listwa przyłączeniowa ze złączkami zaciskowymi	TH09-0006	182,00	223,86
	Listwa przyłączeniowa z zaworami zaciskowymi	TH09-0007	544,00	669,12
	Rama montażowa z nacyniem przeponowym Solo 18, Duo 24/18	TH09-0008	299,00	367,77
	Rama montażowa z nacyniem przeponowym Solo 24, Duo 28/24	TH09-0009	299,00	367,77
	Rama montażowa z nacyniem przeponowym Solo 30,46; Duo 36/30, 36/46	TH09-0010	299,00	367,77
	Maskownica zaworów	TH09-0011	91,00	111,93









AKCESORIA DO KOTŁÓW cd.

Nazwa wyrobu		Numer katalogowy	Cena netto [PLN]	Cena brutto [PLN]
	Zestaw propan (G31) Solo 18, Duo 24/18	TH09-0013	86,00	105,78
	Zestaw propan (G31) Solo 24, Duo 28/24	TH09-0014	86,00	105,78
	Zestaw propan (G31) Solo 30,46; Duo 36/30, 36/46	TH09-0015	86,00	105,78

SYSTEMY POWIETRZNO-SPALINOWE

Nazwa wyrobu		Numer katalogowy	Cena netto [PLN]	Cena brutto [PLN]
	Rura prosta PP=250mm	TH09-0022	13,00	15,99
	Rura prosta PP=500mm	TH09-0023	19,60	24,11
	Rura prosta PP=2000mm	TH09-0024	35,50	43,67
	Rura prosta PP czarna	TH09-0025	24,50	30,14
	Uszczelka PP 80	TH09-0026	4,50	5,54
	Uszczelka PP 125	TH09-0027	4,50	5,54
	Kolano PP 80 45°	TH09-0028	23,50	28,91
	Kolano PP 80 90°	TH09-0029	23,50	28,91

SYSTEMY POWIETRZNO-SPALINOWE cd.

	Nazwa wyrobu	Numer katalogowy	Cena netto [PLN]	Cena brutto [PLN]
	Rura prosta konc. 80/125 250mm	TH09-0030	53,00	65,19
	Rura prosta konc. 80/125 500mm	TH09-0031	58,00	71,34
	Rura prosta konc. 80/125 1000mm	TH09-0032	93,50	115,01
	Kolano koncentryczne 45°	TH09-0033	62,50	76,88
	Kolano koncentryczne 90°	TH09-0034	84,00	103,32
	Wyjście pionowe koncentryczne	TH09-0035	214,50	263,84
	PP wkład elastyczny (54m)	TH09-0036	32,50	39,98
	Przejście dachowe	TH09-0037	140,00	172,20
	Zestaw do szachtu 80/125	TH09-0038	345,50	424,97
	Zestaw przez ścianę 80/125	TH09-0039	290,00	356,70



82-100 Nowy Dwór Gdański
ul. Warszawska 50

tel.: +48 55 888 55 00
fax: +48 55 888 55 01